

Basic Injection Molding Design Guidelines

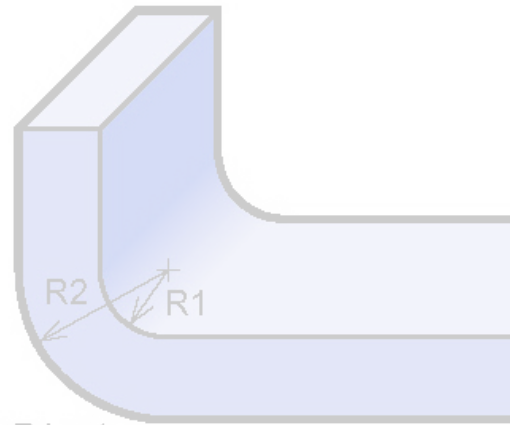

$$R2 = R1 + t$$

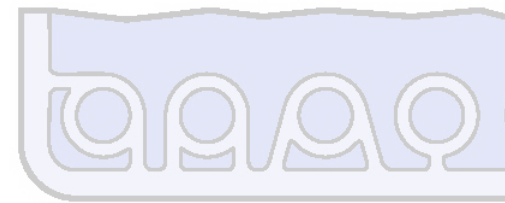
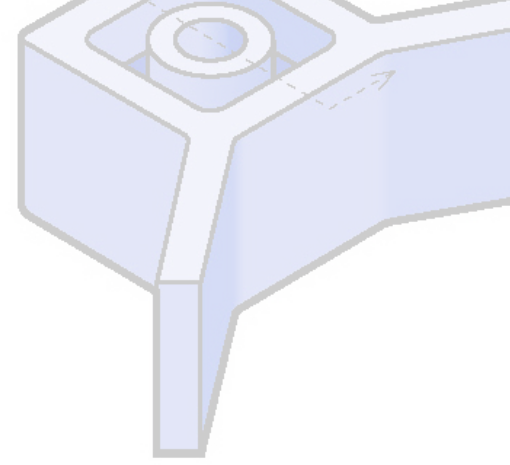
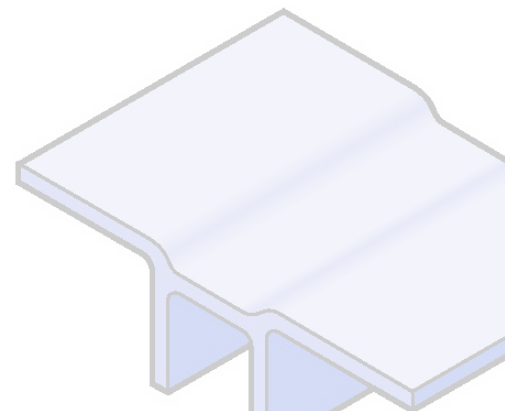
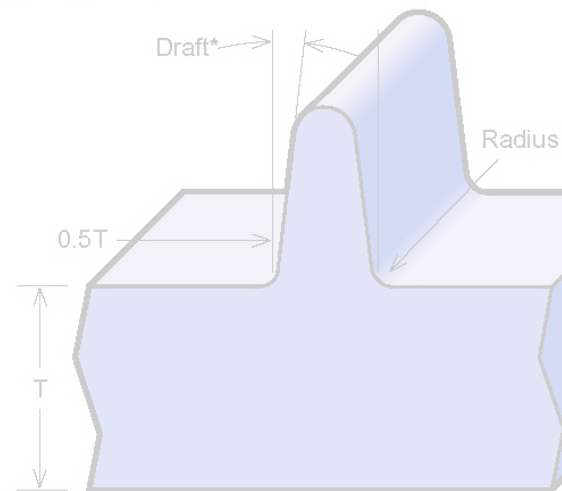

Coring and Wall Thickness

Core or redesign thick areas to create a more uniform wall thickness to prevent sink or voids.

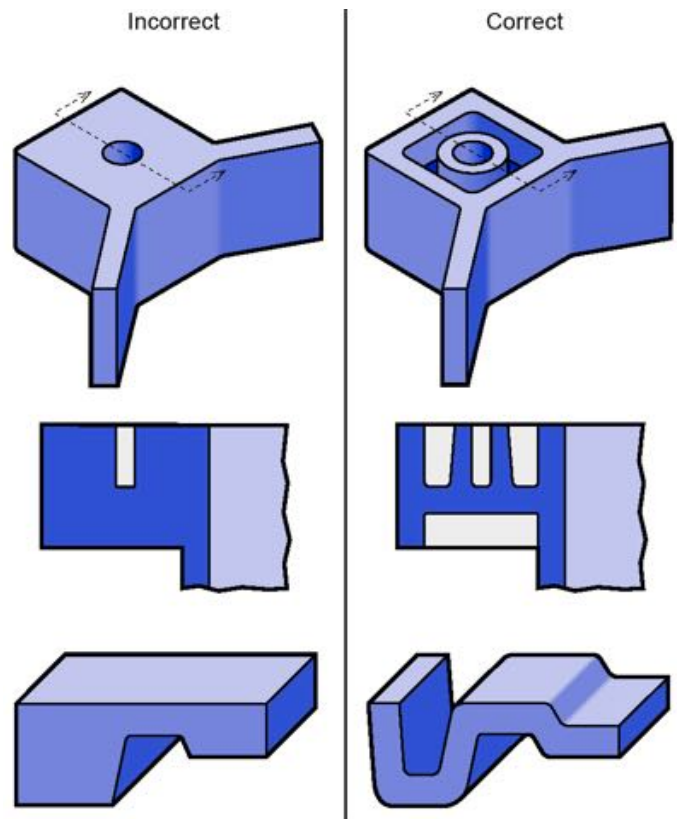

Core out thick sections as shown on the right to maintain a uniform wall thickness

Wall Thickness by Resin Material Guidelines

The proper material selection and observing uniform wall thickness in injection-molded parts, helps avoid potential issues such as sink marks and warpage. We recommended using the guidelines in the table to the right as thicknesses vary by material:

Resin / Material	Inches
ABS	0.045 - 0.140
Acetal	0.030 - 0.120
Acrylic	0.025 - 0.500
Liquid Crystal Polymer	0.030 - 0.120
Long-fiber Reinforced Plastics	0.075 - 1.000
Nylon	0.030 - 0.115
PC (Polycarbonate)	0.040 - 0.150
Polyester	0.025 - 0.125
Polyethylene	0.030 - 0.200
Polyphenylene Sulfide	0.020 - 0.180
Polypropylene	0.025 - 0.150
Polystyrene	0.035 - 0.150
Polyurethane	0.080 - 0.750

Corner Design

Making the outside radius one wallthickness larger than the inside radius will maintain constant wall thickness through corners. $R2 = R1 + t$

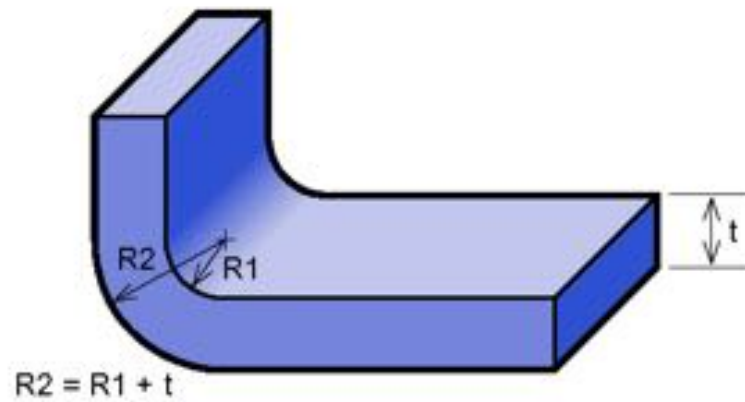
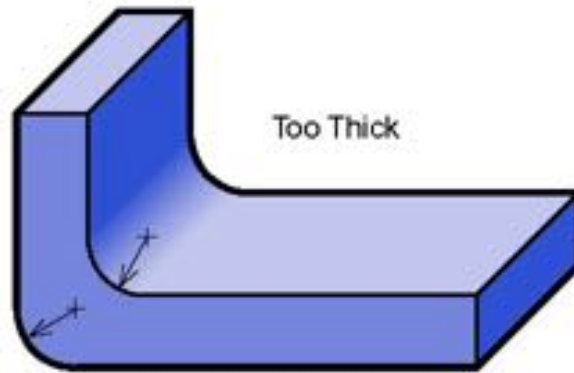
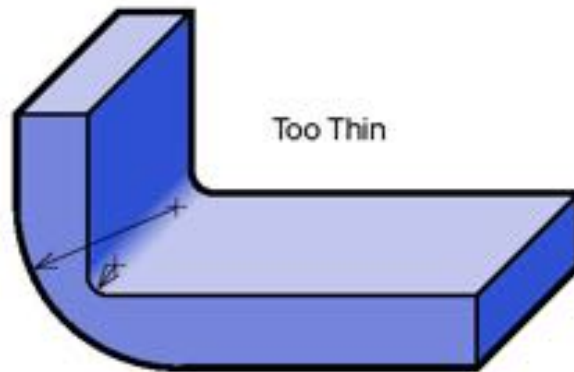

Thickness Transitions

Rounding or tapering thickness transitions will minimize read-through and possible blush or gloss differences. Additionally, blending reduces molded-in stresses and stress concentration associated with abrupt changes in thickness.

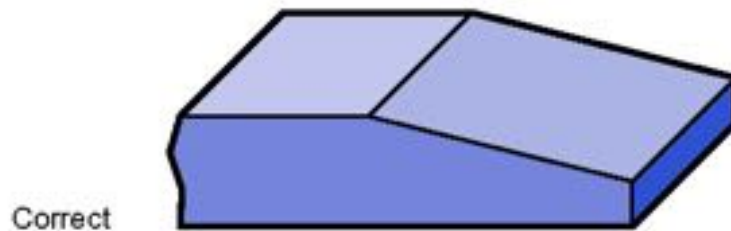
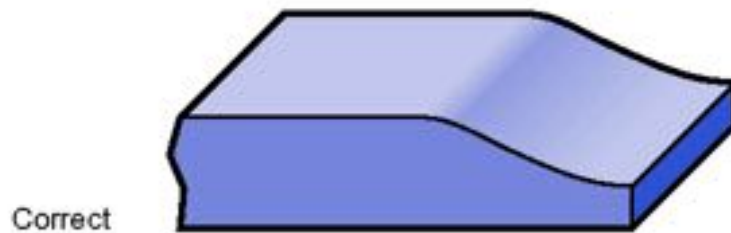
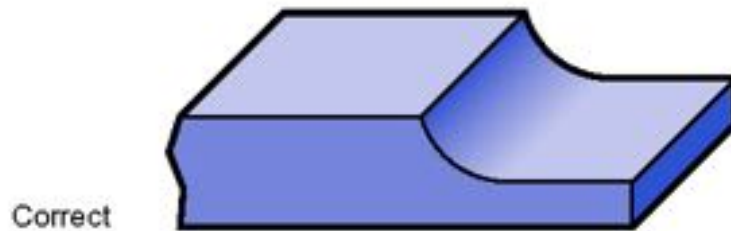
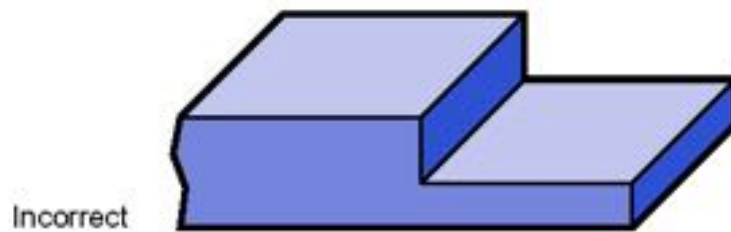

Ribs

Ribs provide a means to augment strength and stiffness in molded parts without increasing overall wall thickness. Other uses for ribs are as follows:

- Act as stops or guides for mechanisms.
- Ribs locate and captivate components of an assembly.
- They provide alignment in mating parts.

Proper rib design involves five main issues: thickness, height, location, quantity, and moldability.

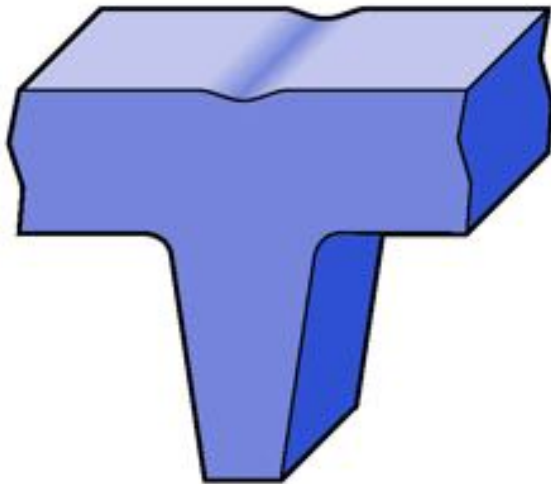

Sink opposite thick rib.

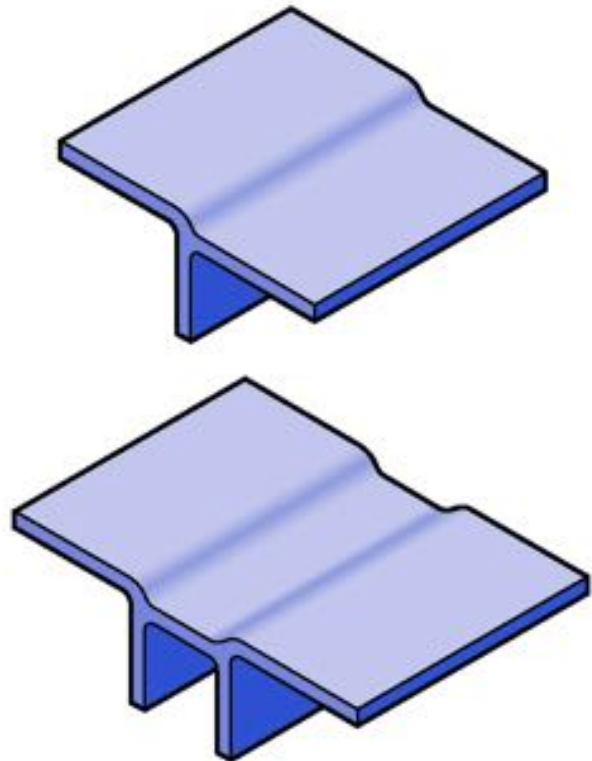

Offset rib to reduce read-through and sink.

Ribs — Continued

Rib Thickness

There are many factors that determine the appropriate rib thickness. Thick ribs often cause sink and cosmetic problems on the opposite surface of the wall to which they are attached. The material, rib thickness, surface texture, color, proximity to a gate, and a variety of processing conditions determine the severity of sink. The illustration (right) gives common guidelines for rib thickness for a variety of materials. These guidelines are based upon subjective observations under common conditions and pertain to the thickness at the base of the rib. Highly glossy, critical surfaces may require thinner ribs.

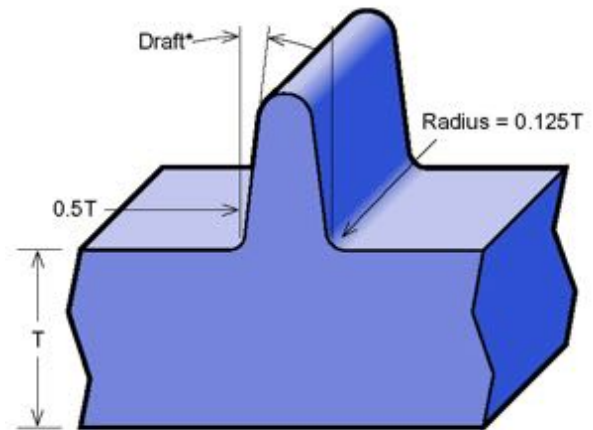

*Minimum 0.5° Per Side

Rib Location & Quantity

The location and quantity of ribs is vital in avoiding exacerbating problems the ribs were intended to correct— e.g., ribs added to increase part strength and prevent breakage may reduce the ability of the part to absorb impacts without failure.

Furthermore, a grid of ribs added to ensure part flatness may lead to mold-cooling difficulties and warpage. Typically much easier to add than remove, ribs should be applied sparingly in the original design and added as needed to fine tune performance.

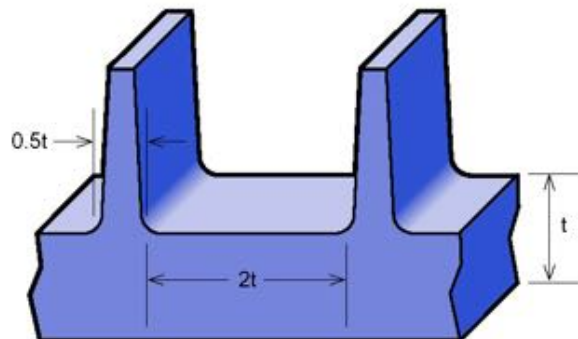
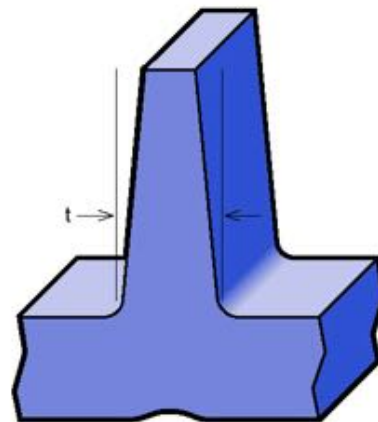

Replace large problematic ribs with multiple shorter ribs.

Bosses

Bosses find use in many part designs as points for attachment and assembly. The most common variety consists of cylindrical projections with holes designed to receive screws, threaded inserts, or other types of fastening hardware. Generally, the outside diameter of bosses should remain within 2.0 to 2.4 times the outside diameter of the screw or insert.

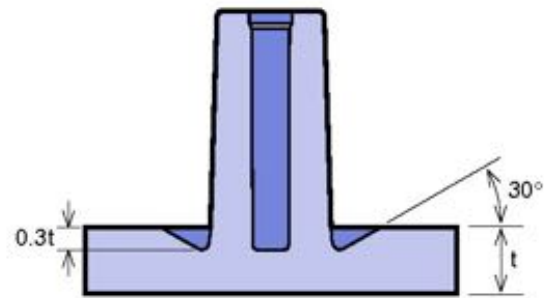
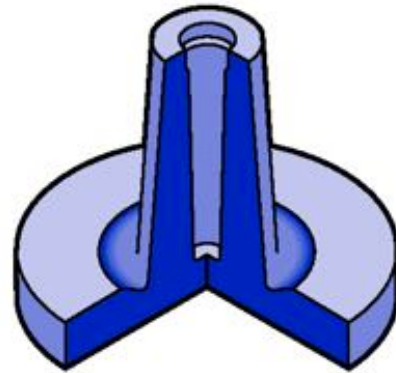
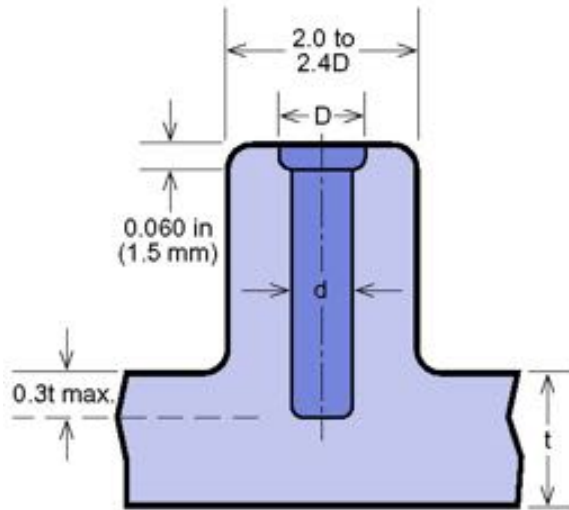

A recess around the base of a thick boss reduces sink.

It is suggested avoiding bosses that merge into sidewalls because they can form thick sections that lead to sink. Proper bosses should be positioned away from the sidewall, and if needed, use connecting ribs for support. Try using open boss designs for bosses near a standing wall.

Incorrect

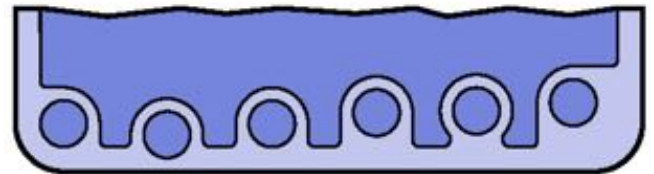

Correct

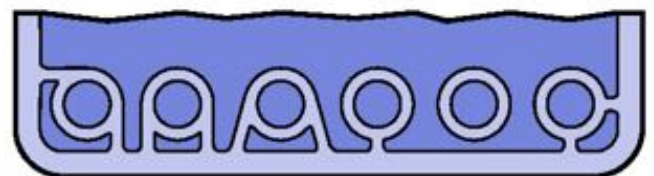

Connecting bosses to walls.

Bosses — Continued

Normally, the boss hole should extend to the base-wall level, even if the full depth is not needed for assembly. Shallower holes can leave thick sections, resulting in sink. Deeper holes reduce the base wall thickness, leading to filling problems, knitlines, or surface blemishes. Because of the required draft, tall bosses (those greater than five times their

outside diameter) can create a filling problem at their top or a thick section at their base. Additionally, the cores in tall bosses can be difficult to cool and support. Think about coring a tall boss from two sides or extending tall gussets to the standoff height instead of than the whole boss.

Boss in Attachment Wall

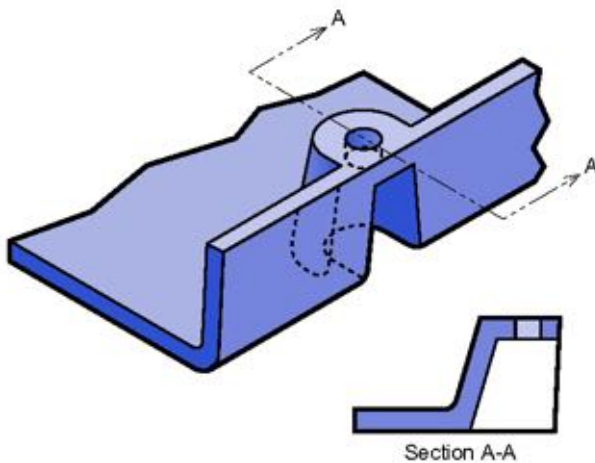

Open bosses maintain uniform thickness in the attachment wall.

Boss Core Depth

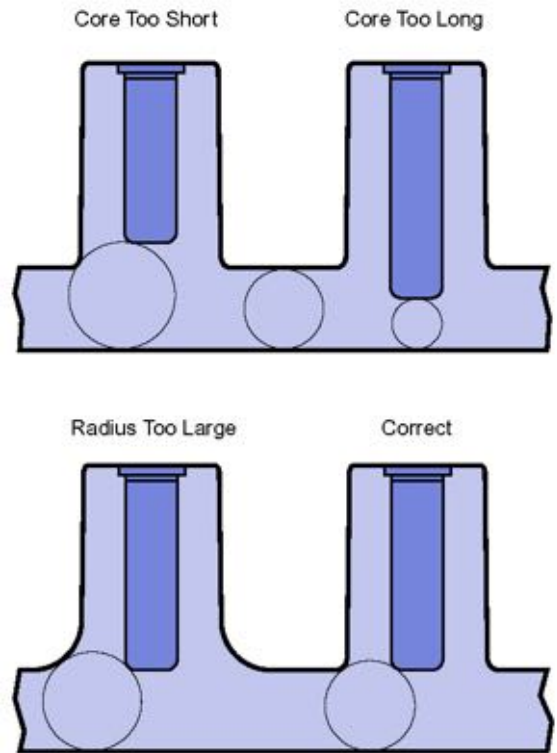

Long-Core Alternatives

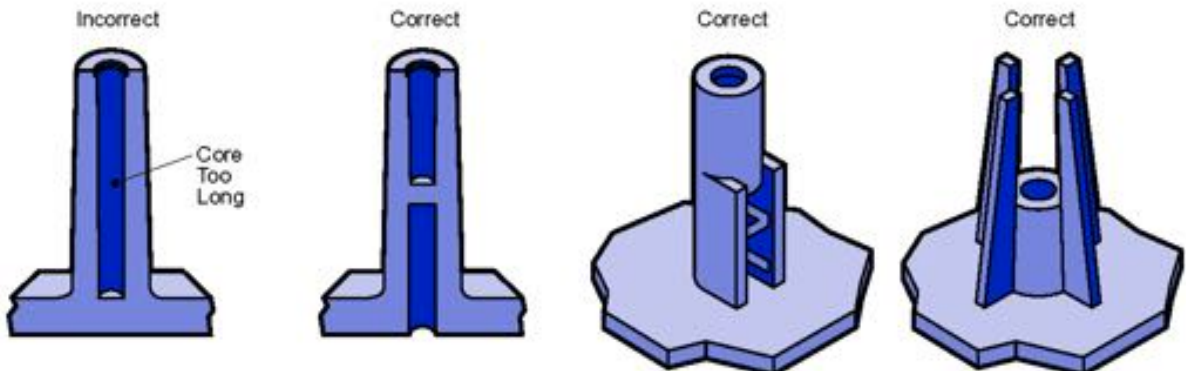

Options to reduce the length of excessively long core pins.

Draft (Draft Angles)

Draft: Providing angles or tapers on product features such as walls, ribs, posts, and bosses that lie parallel to the direction of release from the mold which eases part ejection.

How a specific feature is formed in a mold determines the type of draft needed. Features formed by blind holes or pockets (such as most bosses, ribs, and posts) should taper thinner as they extend into the mold. Surfaces formed by slides may not need draft if the steel separates from the surface before ejection. Other guidelines for designing draft include:

- Draft all surfaces parallel to the direction of mold separation.
- Angle walls and other attributes that are formed in both mold halves to assist ejection and retain uniform wall thickness.
- As a general rule, use the standard one degree of draft plus one additional degree of draft for every 0.001 inch of texture depth.
- Use a draft angle of at least one-half degree for most materials. Design permitting, use one degree of draft for easy part ejection. SAN resins typically require one to two degrees of draft.

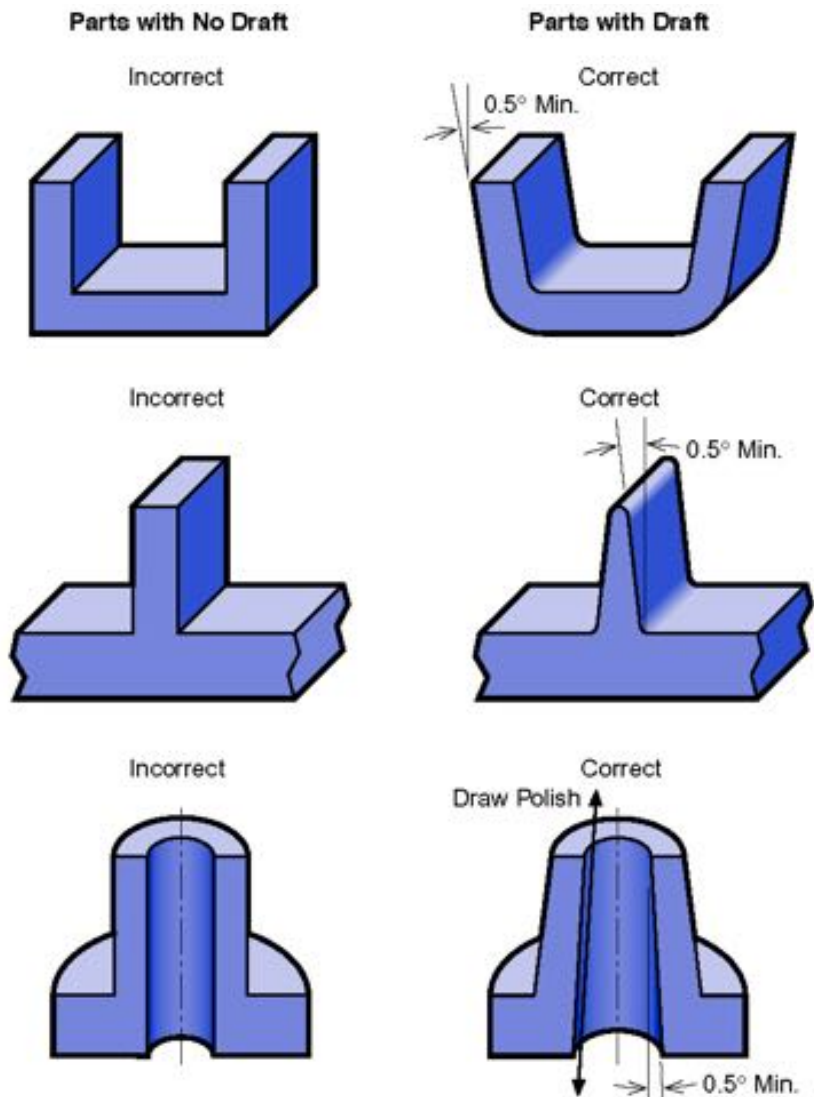

Common draft guidelines.